



Features

- 4 independent full-duplex channels
- Supports 103.1Gb/s and 112Gb/s aggregate bit rates
- QSFP28 MSA compliant
- Up to 100m OM4 MMF transmission
- Operating case temperature: 0 to 70°C
- Single 3.3V power supply
- Maximum power consumption 2.5W
- MTP/MPO optical connector
- RoHS-6 compliant

Applications

- 100GBASE-SR4 100G Ethernet
- 4x28Gb/s Multimode OTN

Absolute Maximum Ratings

Parameter	Symbol	Min.	Max.	Units	Note
Storage Temperature	T _s	-40	85	°C	
Operating Case Temperature	T _{op}	0	70	°C	
Power Supply Voltage	V _{cc}	-0.5	3.6	V	
Relative Humidity (non-condensation)	RH	0	85	%	
Damage Threshold, each Lane	TH _d	3.4		dBm	

Recommended Operating Conditions

Parameter	Symbol	Min.	Typ.	Max.	Units	Note
Operating Temperature	T _{op}	0		70	°C	
Power Supply Voltage	V _{cc}	3.135	3.3	3.465	V	
Data Rate, each Lane			25.78125	27.95	Gb/s	
Control Input Voltage High		2		V _{cc}	V	
Control Input Voltage Low		0		0.8	V	
Link Distance (OM3 MMF)	D1			70	m	
Link Distance (OM4 MMF)	D2			100	m	

Diagnostics Monitoring

Parameter	Symbol	Accuracy	Unit	Notes
Temperature monitor absolute error	DMI_Temp	± 3	°C	Over operating temperature range
Supply voltage monitor absolute error	DMI_VCC	± 0.15	V	Over full operating range
Channel RX power monitor absolute error	DMI_RX_Ch	± 2	dB	1
Channel Bias current monitor	DMI_Ibias_Ch	± 10%	mA	Ch1~Ch4
Channel TX power monitor absolute error	DMI_TX_Ch	± 2	dB	1

Notes:

1. Due to measurement accuracy of different single mode fibers, there could be an additional +/-1 dB fluctuation, or a +/- 3 dB total accuracy.

Transmitter Electro-Optical Characteristics (each Lane)

Parameter	Test Point	Min	Typ.	Max	Units	Notes
Power Consumption				2.5	W	
Supply Current	I _{cc}			0.76	A	
Transceiver Power-on Initialization Time				2000	ms	1
Overload Differential Voltage pk-pk	TP1a	900			mV	
Common Mode Voltage (V _{cm})	TP1	-350		2850	mV	2
Differential Termination Resistance Mismatch	TP1			10	%	At 1 MHz
Differential Return Loss (SDD11)	TP1			See CEI-28G-VSR Equation 13-19	dB	
Common Mode to Differential conversion and Differential to Common Mode conversion (SDC11, SCD11)	TP1			See CEI-28G-VSR Equation 13-20	dB	
Stressed Input Test	TP1a		See CEI-28G-VSR Section 13.3.11.2.1			
Center Wavelength	λ_c	840	850	860	nm	
RMS Spectral Width	$\Delta\lambda_{rms}$			0.6	nm	
Average Launch Power, each Lane	P _{AVG}	-8.4		2.4	dBm	
Optical Modulation Amplitude (OMA), each Lane	P _{OMA}	-6.4		3.0	dBm	4
Difference in Launch Power between any Two Lanes (OMA)	P _{tx, diff}			4.0	dB	
Launch Power in OMA minus TDEC, each Lane		-7.3			dBm	
Transmitter and Dispersion Eye Closure (TDEC), each Lane				4.3	dB	
Extinction Ratio	ER	2.0			dB	
Optical Return Loss Tolerance	TOL			12	dB	

Parameter	Test Point	Min	Typ.	Max	Units	Notes
Encircled Flux						$\geq 86\%$ at $19\mu\text{m}$ $\leq 30\%$ at $4.5\mu\text{m}$
Transmitter Eye Mask Definition {X1, X2, X3, Y1, Y2, Y3}, 5×10^{-5} hits/sample			{0.3, 0.38, 0.45, 0.35, 0.41, 0.5}			5
Average Launch Power OFF Transmitter, each Lane	Poff			-30	dBm	

Notes:

1. Power-on Initialization Time is the time from when the power supply voltages reach and remain above the minimum recommended operating supply voltages to the time when the module is fully functional.
2. Vcm is generated by the host. Specification includes effects of ground offset voltage.
3. 100GBASE-SR4 as being defined by IEEE802.3bm, scaled to 27.97G.
4. Even if the TDP < 0.9 dB, the OMA min must exceed the minimum value specified here.
5. See Figure. Eye Mask Definition below.

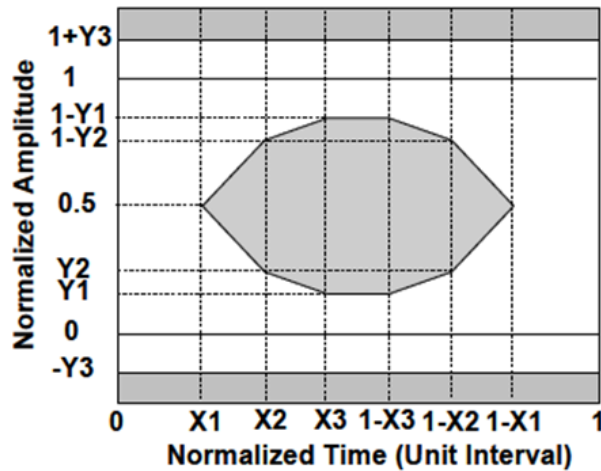

Figure. Eye Mask Definition

Receiver Electro-Optical Characteristics (each Lane)

Parameter	Test Point	Min	Typ.	Max	Units	Notes
Differential Voltage, pk-pk	TP4			900	mV	
Common Mode Voltage (Vcm)	TP4	-350		2850	mV	1
Common Mode Noise, RMS	TP4			17.5	mV	
Differential Termination Resistance Mismatch	TP4			10	%	At 1MHz
Differential Return Loss (SDD22)	TP4			See CEI-28G-VSR Equation 13-19	dB	
Common Mode to Differential conversion and Differential to Common Mode conversion (SDC22, SCD22)	TP4			See CEI-28G-VSR Equation 13-21	dB	
Common Mode Return Loss (SCC22)	TP4			-2	dB	2
Transition Time, 20 to 80%	TP4	9.5			ps	
Vertical Eye Closure (VEC)	TP4			5.5	dB	
Eye Width at 10 ⁻¹⁵ probability (EW15)	TP4	0.57			UI	
Eye Height at 10 ⁻¹⁵ probability (EH15)	TP4	228			mV	
Center Wavelength	λ_c	840	850	860	Nm	
Damage Threshold, each Lane	TH _d	3.4			dBm	3
Average Receive Power, each Lane		-10.3		2.4	dBm	
Receiver Reflectance	R _R			-12	dB	
Receive Power (OMA), each Lane				3.0	dBm	
Receiver Sensitivity (OMA), each Lane	SEN			-9.2	dBm	
Stressed Receiver Sensitivity (OMA), each Lane				-5.2	dBm	5
LOS Assert	LOSA	-30			dBm	
LOS Deassert	LOSD			-12	dBm	
LOS Hysteresis	LOSH	0.5			dB	

Conditions of Stress Receiver Sensitivity Test (Note 5)

Stressed Eye Closure (SEC), Lane under Test	4.3	dB
Stressed Eye J2 Jitter, Lane under Test	0.39	UI
Stressed Eye J4 Jitter, Lane under Test	0.53	UI
OMA of each Aggressor Lane	3	dBm
Stressed Receiver Eye Mask Definition {X1, X2, X3, Y1, Y2, Y3},	{0.28, 0.5, 0.5, 0.33, 0.33, 0.4}	

Notes:

1. Vcm is generated by the host. Specification includes effects of ground offset voltage.
2. From 250MHz to 30GHz.
3. The receiver shall be able to tolerate, without damage, continuous exposure to a modulated optical input signal having this power level on one lane. The receiver does not have to operate correctly at this input power.
4. Measured with conformance test signal at receiver input for BER = 1×10^{-12} .
5. Stressed eye closure and stressed eye jitter are test conditions for measuring stressed receiver sensitivity. They are not characteristics of the receiver.

Block Diagram of Transceiver

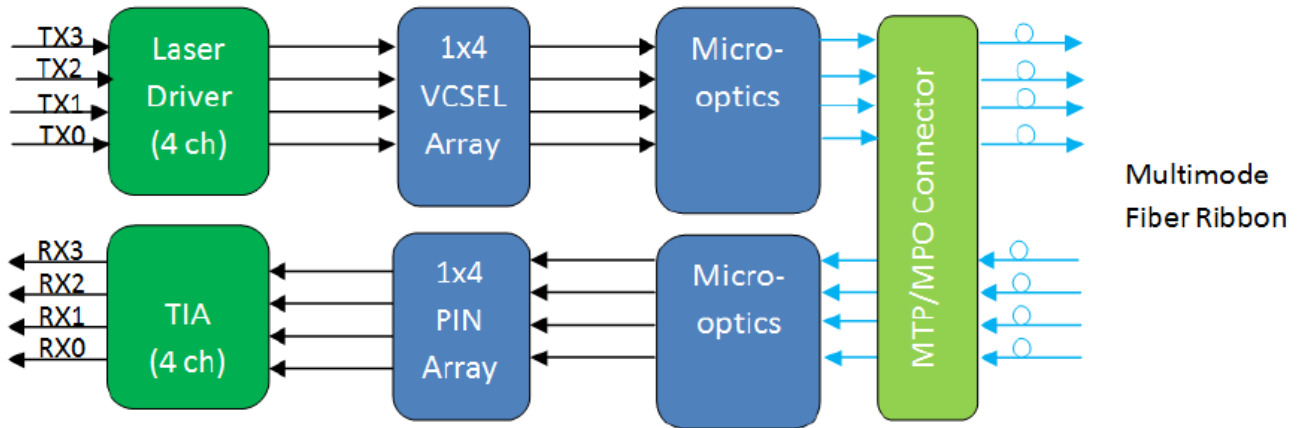

This product is a parallel Quad Small Form-factor Pluggable (QSFP28) optical module that supports 100GBASE-SR4 Ethernet and OTU4 applications. It provides increased port density and total system cost savings. The QSFP28 full-duplex optical module offers 4 independent transmit and receive channels, each capable of up to 28Gb/s operation for an aggregate data rate of up to 112Gb/s on 100 meters of OM4 multi-mode fiber. An optical fiber ribbon cable with an MTP/MPO connector can be plugged into the QSFP28 module receptacle. Proper alignment is ensured by the guide pins inside the receptacle. The cable usually cannot be twisted for proper channel to channel alignment. Electrical connection is achieved through an MSA-compliant 38-pin edge type connector.

The module operates by a single +3.3V power supply. LVCMOS/LVTTL global control signals, such as Module Present, Reset, Interrupt and Low Power Mode, are available with the modules. A 2-wire serial interface is available to send and receive more complex control signals, and to receive digital diagnostic information. Individual channels can be addressed and unused channels can be shut down for maximum design flexibility. The product is designed with form factor, optical/electrical connection and digital diagnostic interface according to the QSFP28 Multi-Source Agreement (MSA). It has been designed to meet the harshest external operating conditions including temperature, humidity and EMI interference. The module offers very high functionality and feature integration, accessible via a two-wire serial interface.

This product converts parallel electrical input signals into parallel optical signals, by a driven Vertical Cavity Surface Emitting Laser (VCSEL) array. The transmitter module accepts electrical input signals compatible with Common Mode Logic (CML) levels. All input data signals are differential and internally terminated. The receiver module converts parallel optical input signals via a photo detector array into parallel electrical output signals. The receiver module outputs electrical signals are also voltage compatible with Common Mode Logic (CML) levels. All data signals are differential and support a data rates up to 28Gb/s per channel. Figure 1 shows the functional block diagram of this product.

A single +3.3V power supply is required to power up the module. Both power supply pins VccTx and VccRx are internally connected and should be applied concurrently. As per MSA specifications the module offers 7 low speed hardware control pins (including the 2-wire serial interface): ModSelL, SCL, SDA, ResetL, LPMode, ModPrsL and IntL.

Module Select (ModSelL) is an input pin. When held low by the host, the module responds to 2-wire serial communication commands. The ModSelL allows the use of multiple QSFP28 modules on a single 2-wire interface bus – individual ModSelL lines for each QSFP28 module must be used.

Serial Clock (SCL) and Serial Data (SDA) are required for the 2-wire serial bus communication interface and enable the host to access the QSFP28 memory map.

The ResetL pin enables a complete module reset, returning module settings to their default state, when a low level on the ResetL pin is held for longer than the minimum pulse length. During the execution of a reset the host shall disregard all status bits until the module indicates a completion of the reset interrupt. The module indicates this by posting an IntL (Interrupt) signal with the Data_Not_Ready bit negated in the memory map. Note that on power up (including hot insertion) the module should post this completion of reset interrupt without requiring a reset.

Low Power Mode (LPMode) pin is used to set the maximum power consumption for the module in order to protect hosts that are not capable of cooling higher power modules, should such modules be accidentally inserted.

Module Present (ModPrsL) is a signal local to the host board which, in the absence of a module, is normally pulled up to the host Vcc. When a module is inserted into the connector, it completes the path to ground through a resistor on the host board and asserts the signal. ModPrsL then indicates a module is present by setting ModPrsL to a “Low” state.

Interrupt (IntL) is an output pin. Low indicates a possible module operational fault or a status critical to the host system. The host identifies the source of the interrupt using the 2-wire serial interface. The IntL pin is an open collector output and must be pulled to the Host Vcc voltage on the Host board.

Pin Assignment

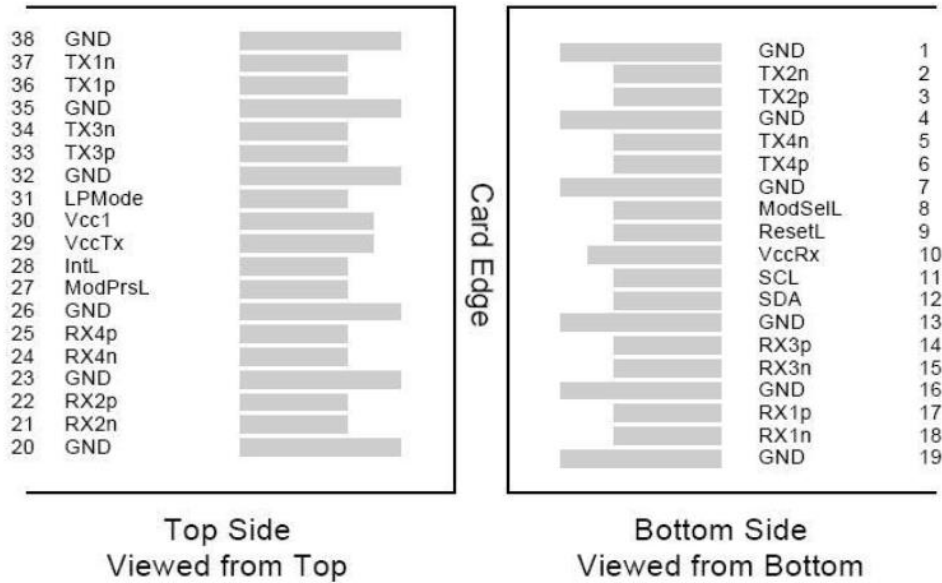

QSFP28 Transceiver Electrical Pad Layout

Pin Description

PIN	Logic	Symbol	Name/Description	Note
1		GND	Ground	1
2	CML-I	Tx2n	Transmitter Inverted Data Input	
3	CML-I	Tx2p	Transmitter Non-Inverted Data output	
4		GND	Ground	1
5	CML-I	Tx4n	Transmitter inverted Data Input	
6	CML-I	Tx4p	Transmitter Non-Inverted Data output	
7		GND	Ground	1
8	LVTLL-I	ModSelL	Module Select	
9	LVTLL-I	ResetL	Module Reset	
10		VccRx	+3.3V Power Supply Receiver	2
11	LVC MOS-I/O	SCL	2-Wire Serial Interface Clock	
12	LVC MOS-I/O	SDA	2-Wire Serial Interface Data	
13		GND	Ground	
14	CML-O	Rx3p	Receiver Non-Inverted Data output	
15	CML-O	Rx3n	Receiver Inverted Data output	
16		GND	Ground	1
17	CML-O	Rx1p	Receiver Non-Inverted Data Output	
18	CML-O	Rx1n	Receiver Inverted Data Output	

PIN	Logic	Symbol	Name/Description	Note
19		GND	Ground	1
20		GND	Ground	1
21	CML-O	Rx2n	Receiver Inverted Data output	
22	CML-O	Rx2p	Receiver Non-Inverted Data output	
23		GND	Ground	1
24	CML-O	Rx4n	Receiver Inverted Data output	
25	CML-O	Rx4p	Receiver Non-Inverted Data output	
26		GND	Ground	1
27	LVTTL-O	ModPrsL	Module Present	
28	LVTTL-O	IntL	Interrupt	
29		VccTx	+3.3V Power Supply transmitter	
30		Vcc1	+3.3V Power Supply	
31	LVTTL-I	LPMode	Low Power Mode	
32		GND	Ground	1
33	CML-I	Tx3p	Transmitter Non-Inverted Data Input	
34	CML-I	Tx3n	Transmitter Inverted Data Output	
35		GND	Ground	1
36	CML-I	Tx1p	Transmitter Non-Inverted Data Input	
37	CML-I	Tx1n	Transmitter Inverted Data Output	
38		GND	Ground	1

Notes:

1. GND is the symbol for signal and supply (power) common for QSFP28 modules. All are common within the QSFP28 module and all module voltages are referenced to this potential unless otherwise noted. Connect these directly to the host board signal common ground plane.
2. VccRx, Vcc1 and VccTx are the receiver and transmitter power suppliers and shall be applied concurrently. Recommended host board power supply filtering is shown in Figure 4 below. Vcc Rx, Vcc1 and Vcc Tx may be internally connected within the QSFP28 transceiver module in any combination. The connector pins are each rated for a maximum current of 1000mA.

Optical Interface Lanes and Assignment

Figure below shows the orientation of the multi-mode fiber facets of the optical connector. Table below provides the lane assignment.

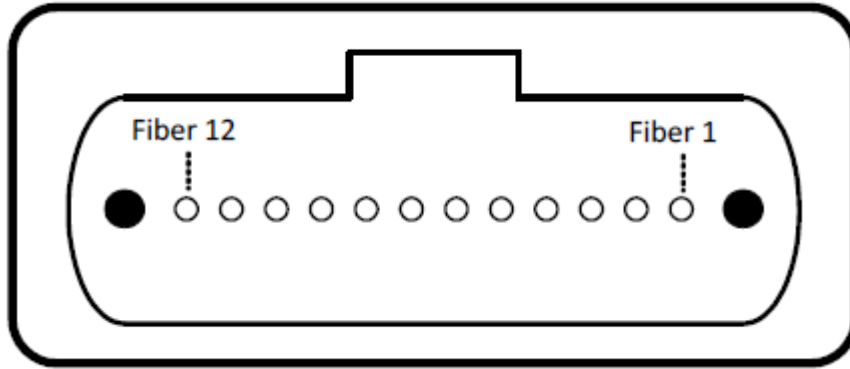

Outside view of the QSFP module MPO

Table: Lane assignment

Fiber #	Lane Assignment
1	RX0
2	RX1
3	RX2
4	RX3
5	Not used
6	Not used
7	Not used
8	Not used
9	TX3
10	TX2
11	TX1
12	TX0

Dimensions

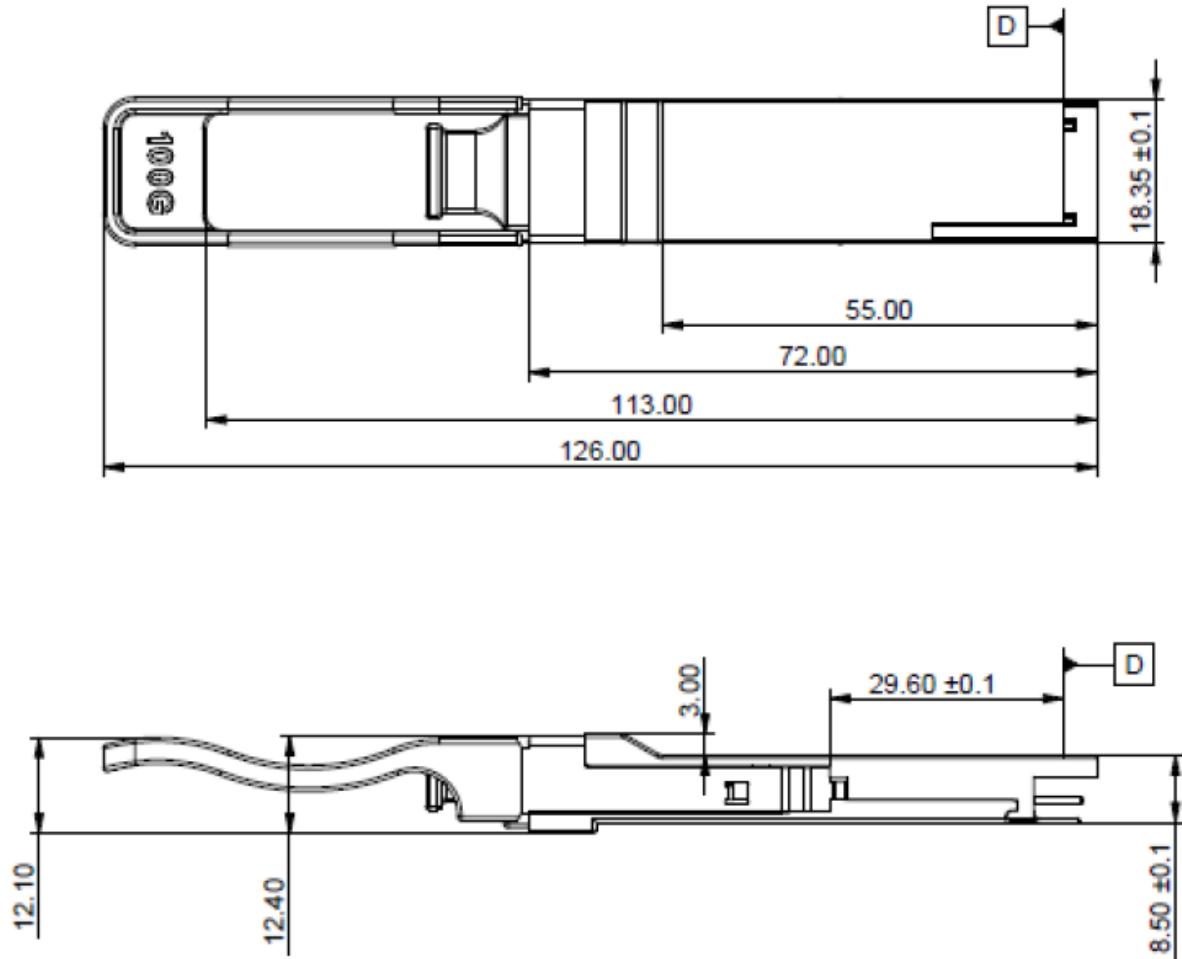

Optical Receptacle Cleaning Recommendations :

All fiber stubs inside the receptacle portions were cleaned before shipment. In the event of contamination of the optical ports, the recommended cleaning process is the use of forced nitrogen. If contamination is thought to have remained, the optical ports can be cleaned using a NTT international Cletop® stick type and HFE7100 cleaning fluid. Before the mating of patch-cord, the fiber end should be cleaned up by using Cletop® cleaning cassette.

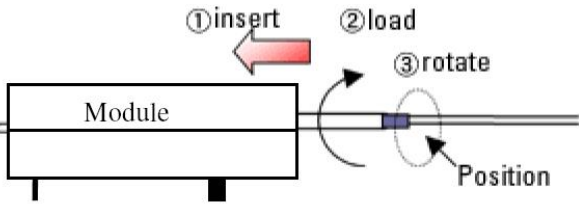
<p>Cleaning of patch-cord</p> 	<p>Cleaning of fiber stub</p>  <ol style="list-style-type: none"> 1. Insert Ensure that stick is held straight when inserting into sleeve. 2. Load Apply sufficient pressure (approx 600-700g) to ensure ferrule a little depressed in sleeve. 3. Rotate Rotate stick clockwise 4-5 times, while ensuring direct contact with ferrule end-face is maintained. <p><i>Notice: Number of possible wipes: Maintenance (repair) ~1 use / piece Equipment construction: 4 uses / piece (max.)</i></p>
---	---

Note: The pictures were extracted from NTT-ME website. And the Cletop® is a trademark registered by NTT-ME

Ordering Information

OP	6	C	S	10	13	C	M
Product Code:	Data Rate:	Type:	S=Single- mode;	Reach:	Wavelength:	Operating Temperature:	Additional Feature:
5=GBIC;	A=155Mb/s;	M=Multi- mode; W=BWDM;	X1=Under 150m;	Normal:	85=850nm;	C=Commercial Purpose (0~70°C);	M=Digital Optical Monitoring (DOM)
6=SFP-LC;	B=622Mb/s;	B=DUAL-BWDM;	X2=220m;		13=1310nm;	I= Industrial Purpose (Extended Range)	(RX_LOS for Copper TX);
7=XFP;	C=1.25Gb/s;	C=CWDM;	X3=300m;		15=1550nm;		F=with Fiber Stub;
8=XENPAK;	D=2.125Gb/s;	D=DWDM;	X5=550m;		00=Copper T (RJ-45)		I=with Isolator;
9=X2;	E=2.5Gb/s;	T=Copper-T (RJ-45)	02=2km;		CWDM:	S=Customized Style	
A=SFP+ (SFP28);	F=4.25Gb/s;	E=GEPON ONU;	10=10km;		27=1270nm;		
C=QSFP+ (QSFP28);	G=3.1Gb/s;	F=GEPON OLT;	70=70km;		47=1470nm;		
F=CFP;	J=2.97G;	G=GPON ONU;	A0=100km;		61=1610nm		
G=CFP2;	P=6.144G;	H=GPON OLT	C0=120km		BWDM:		
H=CFP4;	Q=7.37G;	X=MMF/SMF			B3=Tx1310/Rx1550; B5=Tx1550/Rx1310;		
P=SFP-SC; Q=SFP- MTRJ	H=8.5Gb/s;				B4=Tx1310/Rx1490; B9=Tx1490/Rx1310;		
	K=10Gb/s;				51=Tx1510/Rx1570; 57=Tx1570/Rx1510;		
	T=1/10Gb/s				27=Tx1270/Rx1330; 33=Tx1330/Rx1270;		
	L=16Gb/s;				B2=Tx1270/Rx1577; B7=Tx1577/Rx1270		
	R=20Gb/s;				T2=2TX1310nm; T3=TX1310nm;		
	X=25Gb/s;				T5=TX1550nm		
	S=40Gb/s;				DWDM:		
	W=100Gb/s (4x25G or 10x10G);				17=Channel 17		
	M=100Base-X SGMII;				34= Channel 34		
	N=100/1000Base-X SGMII;				00=Channel 17~61 Tunable		

Model Number	Part Number	Voltage	Temperature
QSFP-100G-SR4-OTN	OPCW-MX1-85-CBT	3.3V	0°C to 70 °C

Note: All information contained in this document is subject to change without notice.